

# FONIX® 6500-CX REALTIME HEARING AID TEST SYSTEM

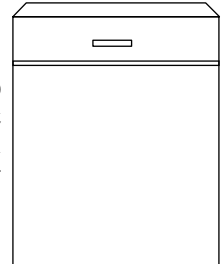

FONIX 6050  
SOUND CHAMBER  
WITH BUILT-IN BATTERY  
VOLTAGE SELECTOR  
AND TELECOIL



SOUND CHAMBER STAND

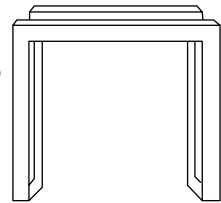

M1550E MICROPHONE

## PROGRAMMING OPTIONS

ANSI '87 and '96  
IEC  
JIS (JAPANESE STANDARD)  
MULTI-CURVE  
AVG  
I/O  
0/60  
GAIN  
ID  
OES  
STAR/DSIN/ENHANCED DSP  
PROFILER  
INSITU or CIC  
VA CORFIG  
RBX STANDARD

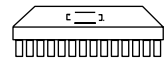
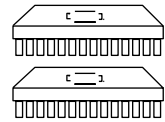

## WinCHAP SOFTWARE

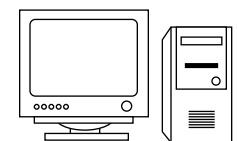

RS232 COMPUTER INTERFACE

## COUPLERS AND ADAPTERS

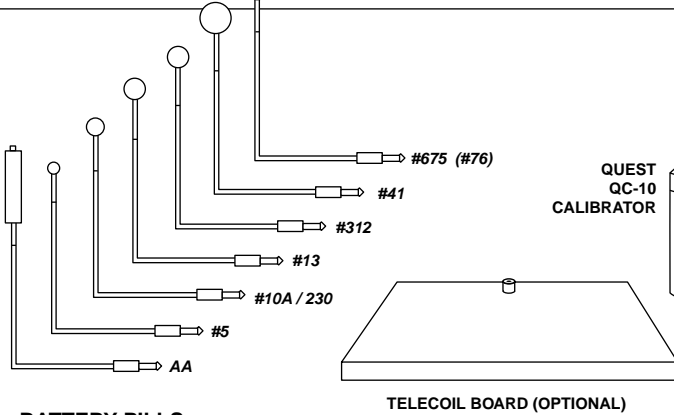
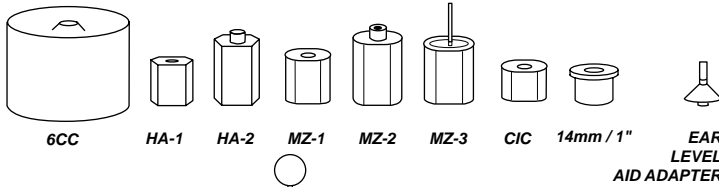

## QUICK-PROBE II OPTION

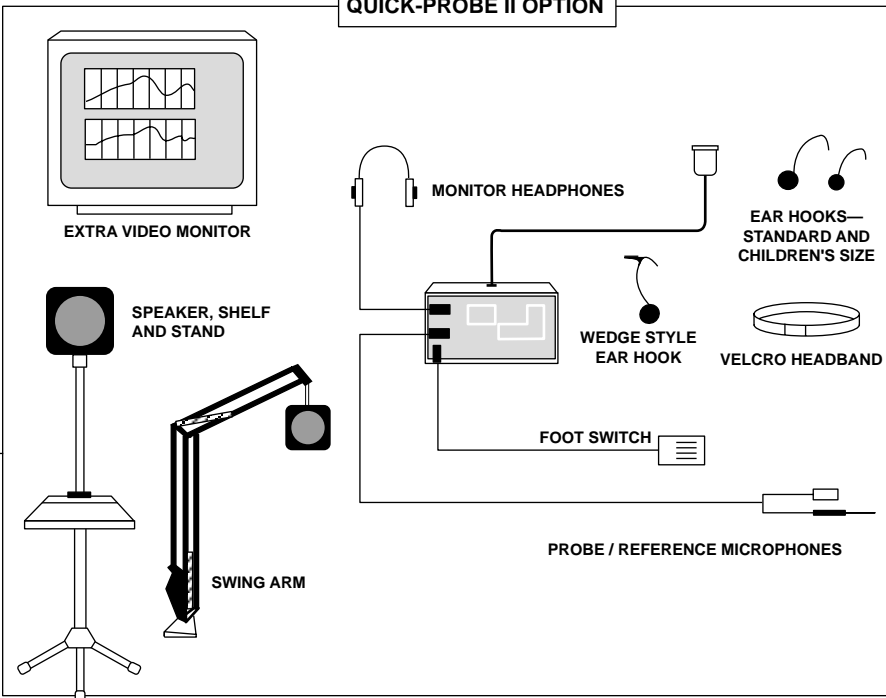

FRYE ELECTRONICS, INC.  
P.O. Box 23391 • Tigard, OR 97281-3391 • USA  
(503) 620-2722 • (800) 547-8209  
Fax: (503) 639-0128  
www.frye.com • e-mail: sales@frye.com